









1. Features

This product is a waterproof LED controller suitable for outdoor use. It has brightness, color temperature, RGB, RGBW and RGB+CCT output modes, and controlled by RF remote controller.

-  Support third party voice control (2.4GHz gateway is needed)
-  16 Millions of colors to choose
-  Smartphone APP control (2.4GHz gateway is needed)
-  Color temperature 2700K~6500K
-  2.4GHz RF remote control control distance 30m
-  Dim brightness/ Saturation
-  Signal transmitting & modes synchronization
-  Waterproof and dustproof grade IP67
-  DMX512 controllable (DMX512 LED transmitter is needed)

2. Parameters

Model No.: LS2-WP
 Input Voltage: DC12V~36V
 Output: 6A/Channel
 Total Output Max: 20A
 RF: 2.4GHz
 Remote Control Distance: 30m
 Connection: Common anode
 Working Temperature: -20~45°C

Waterproof 5-in-1 LED Controller
 Model No.: LS2-WP

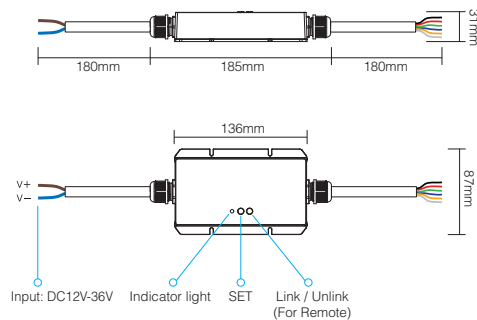

3. Function Instruction

3.1. Switching Output Mode

Short press the " SET " button, indicator lamp change color if switch mode successfully, different colors mean different output mode, details see below sheet.

Indicating Light Color	Output Mode
White Light	Single Color Mode
Yellow Light	Dual White Mode
Red Light	RGB Mode
Green Light	RGBW Mode
Blue Light	RGB+CCT Mode

3.2. Signal transmitting

One lighting fixture can transmit the signals from the remote control to another lighting fixture within 30m, as long as there is a lighting fixture within 30m, the remote control distance can be limitless.

3.3. Modes synchronization

Different lighting fixture can work synchronously when they are started at different times, controlled by the same remote, under same dynamic mode and within 30m distance.

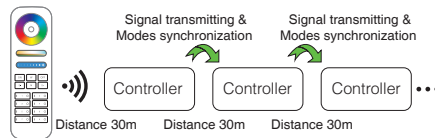

3.4. Dynamic Mode Sheet

Note: only suitable for RGB/RGBW/RGB+CCT output mode.

Number	Dynamic Mode	Brightness / Saturation / Speed
1	Mardi gras	Adjustable
2	Automatic color change	
3	Sam	
4	Gemstone	
5	Twilight	
6	American	
7	Fat tuesday	
8	Party	
9	Slow color splash	

4. Connect diagram



Controller input voltage must be in accordance with the required voltage of LED Strips.

Input: DC12V-36V
Brown: V+
Blue: V-

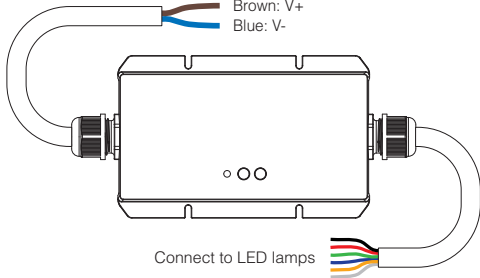

Connect to LED lamps

Note: the connection method is different for different output mode. Please connect it according to below sheet.

Output Mode (LED Wiring)						
Mode \ Wire	Black	Red	Green	Blue	White	Yellow
Single Color	V+	W	W	W	W	W
Dual White	V+	CW	CW	WW	WW	
RGB	V+	R	G	B		
RGBW	V+	R	G	B	W	
RGB+CCT	V+	R	G	B	CW	WW

Single Color

Output mode connection diagram

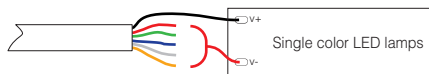

Dual White

Output mode connection diagram



RGB

Output mode connection diagram

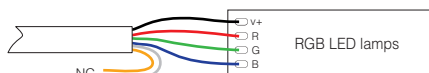

RGBW

Output mode connection diagram

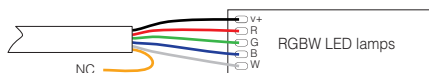

RGB+CCT

Output mode connection diagram

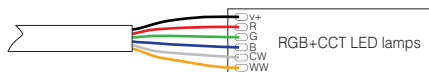

5. RF Remote Link / Unlink

- Link:**
1. Short press the " Link/Unlink " button once on the LED controller (or switch off the controller power. After 10 seconds, switch on again). The indicator light flashes red and green alternately.
 2. Short press Link/Unlink button on the remote (i.e. " | " or " ON ") 3 times within 3 seconds. The green light flashing 3 times slowly means linking successfully.

- Unlink:** Long press " Link/Unlink " button on the LED controller for 3 seconds. The red light flashing 10 times quickly means unlink successfully. (Or follow the unlinking steps on the remote instruction.)

Note:

Remote controller need to be purchased separately. The remote linking and unlinking method, please see details on remote instruction.

Compatible with these remote controls (Purchased separately)

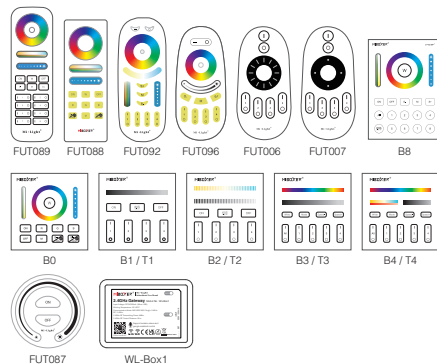

6. Attention

1. Please check whether the input voltage of the constant voltage power supply is in accordance with the controller, and please check the connection of both the cathode and anode.
2. Non-professional user cannot dismantle the controller directly, otherwise, it may cause fire and electric shock.
3. Please do not use controller around the mental area and high magnetic field, otherwise, it will badly affect the control distance.



Made in China