

MiBOXER[®] | **Mi • Light**
Subordinate New Brand

100W RGB+CCT LED Floodlight

Model No.: FUTT07

1. Product Introduction

This product is made of a aluminium alloy bottom case and imported material covers with fashionable appearance, waterproof and dustproof, energy saving and environmental protecting, etc features. Widely used on park, apartment, gardens and street, etc.



RGB+CCT 16 Millions of colors to choose



2.4G RF wireless transmission technology



Dim brightness/ Saturation



Signal transmitting & Modes synchronization



Color temperature 2700K~6500K



Remote control Control distance 30m



Beam Angle 160°



Smartphone APP control (2.4GHz gateway is needed)



Waterproof and dustproof grade IP65



Support third party voice control (2.4GHz gateway is needed)

FUTT07 (100W)

Input Voltage: AC100~240V 50/60Hz

Power: 100W

Working Temperature: -20~45°C

Color Temperature: 2700K~6500K

Luminous Flux: 8500LM

Light Efficiency: 85LM/W

Standby Power Consumption: 0.65W

CRI:>80 PF: >0.9

Beam Angle: 160°

IP Rate: IP65

RF: 2.4GHz

Control Distance: 30m

Lifespan: 50000 hours

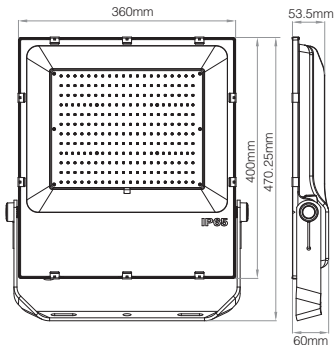

3. Dynamic Mode Sheet

Number	Dynamic Mode	Brightness / Saturation / Speed
1	Mardi Gras	Adjustable
2	Automatic color change	
3	Sam	
4	Gemstone	
5	Twilight	
6	American	
7	Fat Tuesday	
8	Party	
9	Slow Color Splash	

4. Connection Diagram

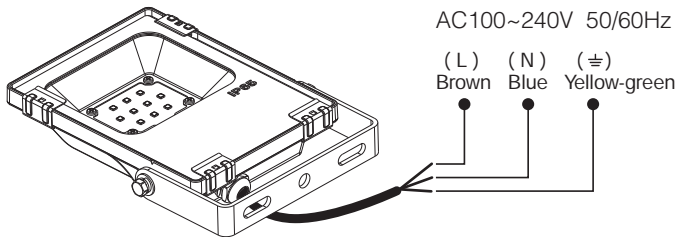

FUTT07

5. Signal transmitting

One lighting fixture can transmit the signals from the remote control to another lighting fixture within 30m, as long as there is a lighting fixture within 30m, the remote control distance can be limitless.

6. Modes synchronization

Different lighting fixture can work synchronously when they are started at different times, controlled by the same remote, under same dynamic mode and within 30m distance.

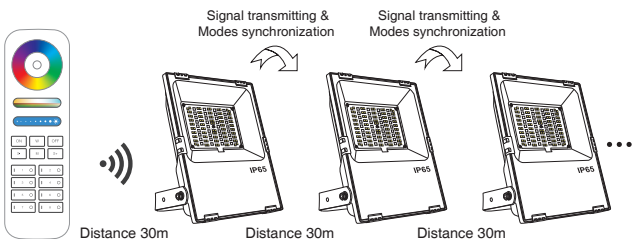

7. Link/Unlink

Compatible with these remote controls (Purchased separately)



NOTE:

Lighting can be working after linking with remote; for more details, pls read the remote instruction.

8. Attention

1. When install the lighting fixtures, pls switch off the power to make sure the safty.
2. The working power is high voltage alternating current, so it must be far away from people and must with ground connection.
3. As the power is large, user must choose suitable power cable when connecting.
4. Non-professional user cannot dismantle the lighting fixtures directly, otherwise, it may cause fire and electric shock.
5. Please do not use lighting fixtures around the mental area and high magnetic field, otherwise, it will badly affect the control distance.
6. Users must be correct, strict and solid to install the lighting fixtures; do not use the lighting fixtures on strenuous vibration area.



Signal transmitting &
Modes synchronization

Made in China